

## High Intensity Pulsed Laser Diodes 1550 HI-Series

### Features

- High intensity output
- Low divergence
- Excellent temperature stability
- Hermetic and custom designed package
- High reliability

### Applications

- Eye safe range finding
- Surveying equipment
- "Friend or Foe" identification
- Laser radar
- Security barrier

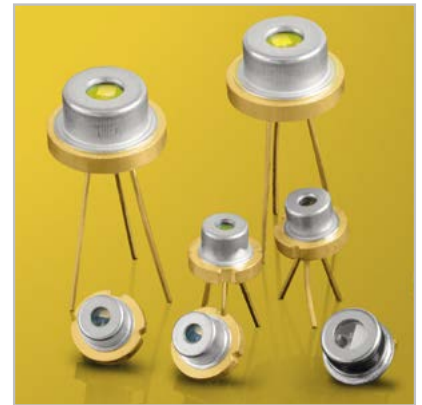

### Optical Characteristics at $t_{RT} = 21^{\circ}\text{C}$ , $I_{FM}$

	Min	Typ	Max	Units
Wavelength of peak radiant intensity $\lambda$	1540	1555	1580	nm
Spectral bandwidth $\Delta\lambda$ at 50% intensity points at $I_{FM}$		25		nm
Wavelength temperature coefficient		0.6		nm/ $^{\circ}\text{C}$
Beam spread (50% peak intensity)				
Parallel to junction plane $\parallel$		12		Degrees
Perpendicular to junction plane $\perp$		25		Degrees

## Single Chips

Typical single chip characteristics at  $t_{RT} = 21\text{ °C}$ ,  $t_w = 100\text{ ns}$ ,  $P_{rr} = 1\text{ kHz}$

Parameter	HI155G1S04X	HI155G1S07X
$P_O$ at $I_{FM}$ (typ.)	11 W	19 W
Emitting area	100 x 1 $\mu\text{m}$	180 x 1 $\mu\text{m}$
Max peak forward current $I_{FM}^*$	30 A	46 A
$I_{TH}$ typ	0.6 A	0.9 A
Forward voltage ( $V_F$ ) at $I_{FM}$	9 V	8 V

\*  $I_{FM}$  is the maximum peak current under any drive condition and is applicable to devices operated for short and intermittent duration such as in hand held range finders.

For applications that demand continuous use at maximum duty factor, we recommended  $I_{FM}$  at 50% to ensure longevity. High temperature operation will reduce peak power and MTF so for optimal performance under high stress conditions it is important to provide an adequate heat sink.

## Absolute Maximum Ratings

Maximum ratings	Limiting values
Peak reverse voltage	6 V
Pulse duration	150 ns
Duty factor	0.1%
Temperature	
- Storage	-55 °C to + 100 °C
- Operating	-45 °C to + 85 °C
Lead soldering	
- 5 seconds max at	200 °C

### Note:

High Temperature operation will reduce peak power and MTF so for optimal performance it is important to provide an adequate heat sink.

Figure 1:  
Peak Power vs. Current for 100  $\mu\text{m}$  (21 °C, F/0)

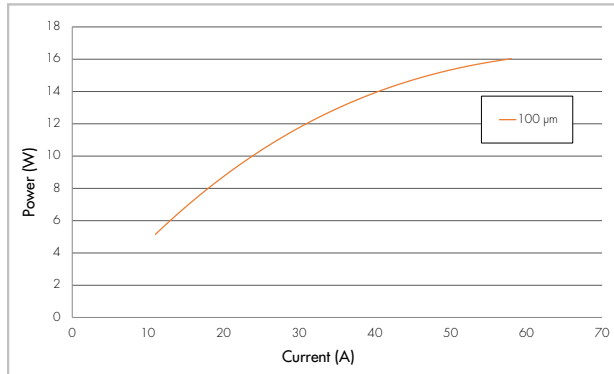

Figure 2:  
Peak Power vs. Current for 180  $\mu\text{m}$  (21°C, F/0)

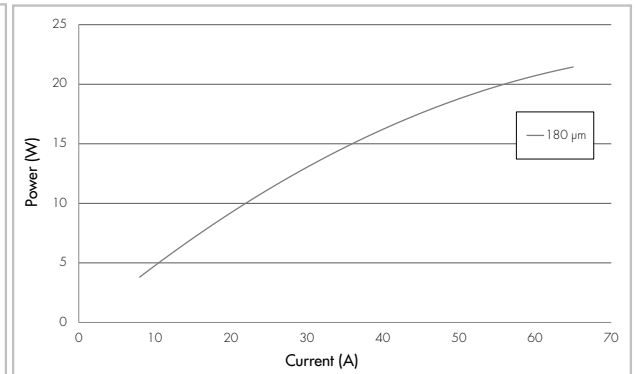

Figure 3:  
Relative Radiant Intensity (%) vs. F-Number

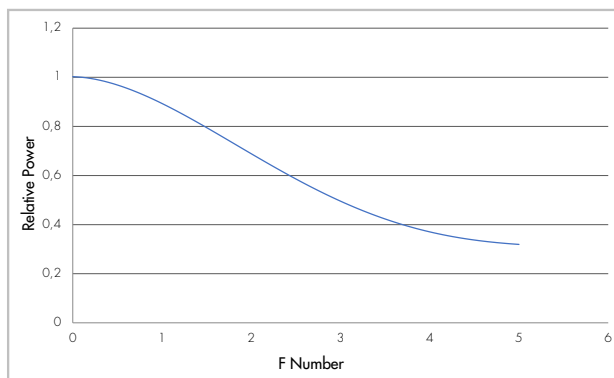

Figure 4:  
Typical Peak Optical Output Power vs. Temperature

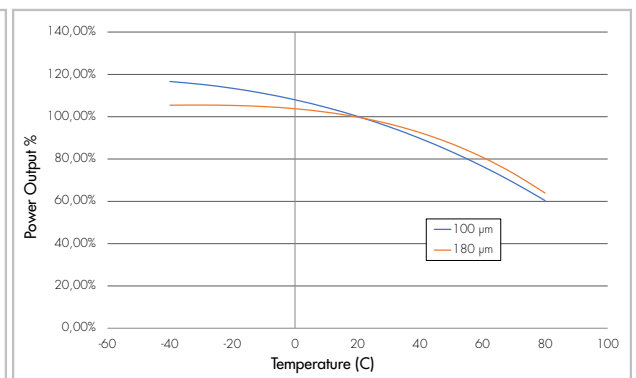

Figure 5:  
Typical Static Forward Voltage ( $V_f$ ) vs. Current

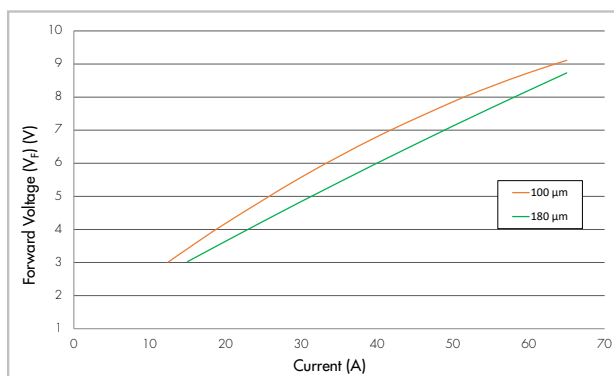

Figure 6:  
Typical Wavelength vs. Temperature

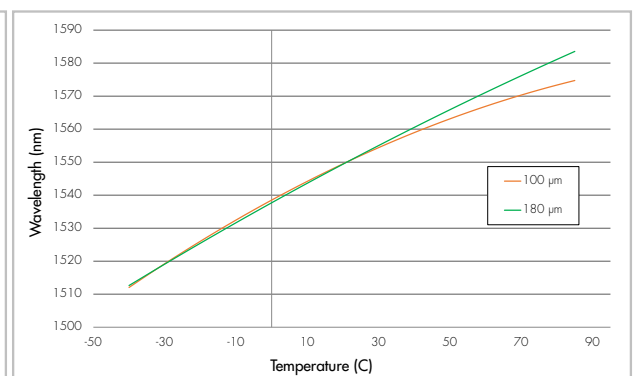

Figure 7:  
Typical Beam Divergence Parallel and Perpendicular to the Junction Plane

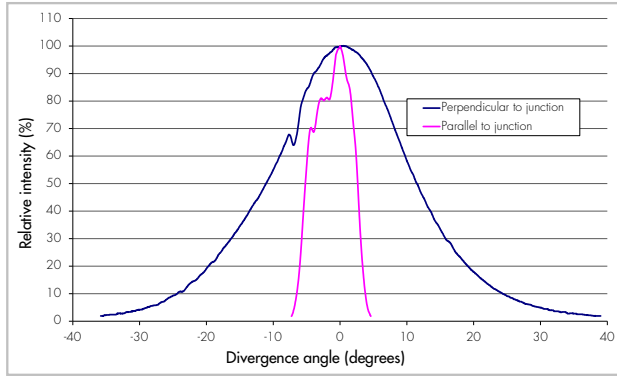
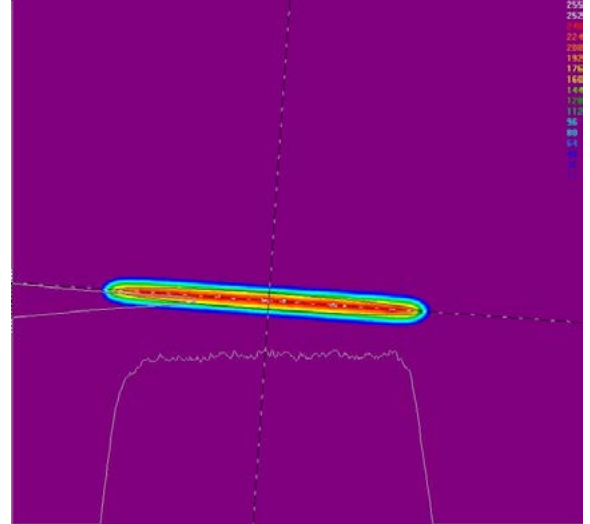
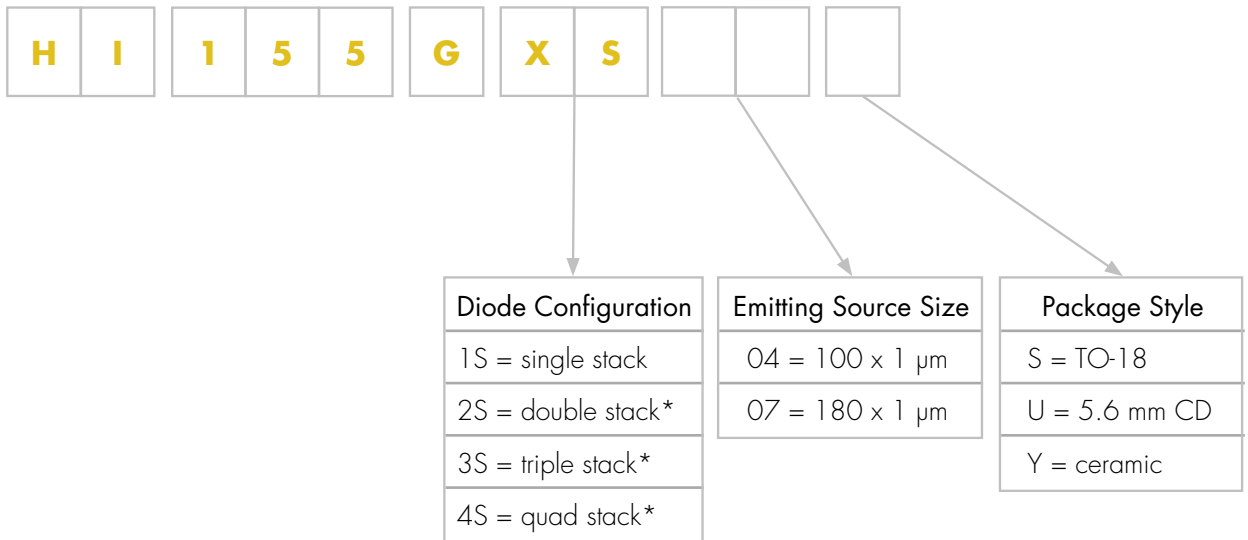

Figure 8:  
Typical Near Field Emission



### Product Number Designations



\* Available upon demand

## Package Drawings

### Package S TO-18

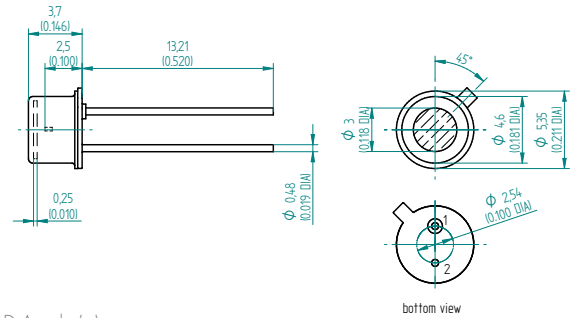

Package S: Pin Out: 1. LD Anode (+),  
2. LD Cathode (-) Case,  
Inductance 5.2 nH

### Package U 5.6 mm CD

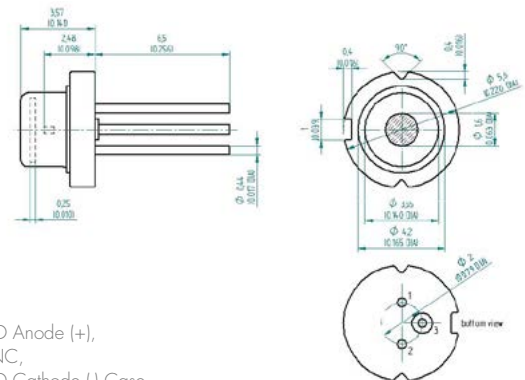

Package U: Pin Out: 1. LD Anode (+),  
2. NC,  
3. LD Cathode (-) Case,  
Inductance 5.0 nH

### Package Y ceramic carrier

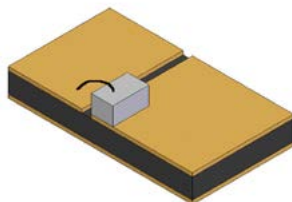

1. Anode left  
2. Cathode right

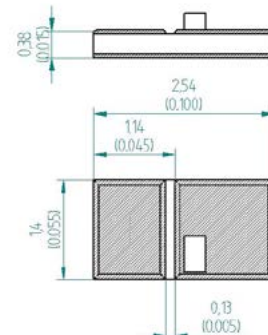

Package Y: Pin Out: 1. LD Anode (+),  
2. LD Cathode (-) Case,  
Inductance 1.6 nH

## Product Changes

LASER COMPONENTS reserves the right to make changes to the product(s) or information contained herein without notice. No liability is assumed as a result of their use or application.

## Ordering Information

Products can be ordered directly from LASER COMPONENTS or its representatives. For a complete listing of representatives, visit our website at [www.lasercomponents.com](http://www.lasercomponents.com)

Custom designed products are available on request.

## Laser Safety

### Personal Hazard:

Depending on the mode of operation, these devices emit highly concentrated non visible infrared light which can be hazardous to the human eye. Products which incorporate these devices have to follow the safety precautions given in IEC 60825-1 "Safety of laser products".

### Handling Precautions:

Products are subject to the risks normally associated with sensitive electronic devices including static discharge, transients, and overload.



#### Germany & Other Countries

Laser Components Germany GmbH  
Tel: +49 8142 2864 - 0  
Fax: +49 8142 2864 - 11  
[info@lasercomponents.com](mailto:info@lasercomponents.com)  
[www.lasercomponents.com](http://www.lasercomponents.com)

#### France

Laser Components S.A.S.  
Tel: +33 1 39 59 52 25  
Fax: +33 1 39 59 53 50  
[info@lasercomponents.fr](mailto:info@lasercomponents.fr)  
[www.lasercomponents.fr](http://www.lasercomponents.fr)

#### United Kingdom

Laser Components (UK) Ltd.  
Tel: +44 1245 491 499  
Fax: +44 1245 491 801  
[info@lasercomponents.co.uk](mailto:info@lasercomponents.co.uk)  
[www.lasercomponents.co.uk](http://www.lasercomponents.co.uk)

#### Nordic Countries

Laser Components Nordic AB  
Tel: +46 31 703 71 73  
Fax: +46 31 703 71 01  
[info@lasercomponents.se](mailto:info@lasercomponents.se)  
[www.lasercomponents.se](http://www.lasercomponents.se)

#### USA

Laser Components USA, Inc.  
Tel: +1 603 821 - 7040  
Fax: +1 603 821 - 7041  
[info@laser-components.com](mailto:info@laser-components.com)  
[www.laser-components.com](http://www.laser-components.com)